



Available online at www.sciencedirect.com



Journal of The Franklin Institute 00 (2015) 1–17

~~Journal of~~
the
Franklin
~~Institute~~
www.elsevier.com/locate/jfranklin

Data-Driven Model Reference Control Design by Prediction Error Identification

L. Campestrini^a, D. Eckhard^b, A. S. Bazanella^a, M. Gevers^c

^a*Department of Automation and Energy, Universidade Federal do Rio Grande do Sul, Porto Alegre-RS, Brazil*

^b*Department of Pure and Applied Mathematics, Universidade Federal do Rio Grande do Sul, Porto Alegre-RS, Brazil*

^c*Department of Mathematical Engineering, Université Catholique de Louvain, Louvain-la-Neuve, Belgium*

Abstract

This paper deals with Data-Driven (DD) control design in a Model Reference (MR) framework. We present a new DD method for tuning the parameters of a controller with a fixed structure. Because the method originates from embedding the control design problem in the Prediction Error identification of an ideal controller, it is baptised as Optimal Controller Identification (OCI). Incorporating different levels of prior information about the ideal controller leads to different design choices, which allows to shape the bias and variance errors in its estimation. It is shown that the limit case where all available prior information is incorporated is tantamount to model-based design. Thus, this methodology also provides a framework in which model-based design and DD design can be fairly and objectively compared. This comparison reveals that DD design essentially outperforms model-based design by providing better bias shaping, except in the full order controller case, in which there is no bias and model-based design provides smaller variance. The practical effectiveness of the design methodology is illustrated with experimental results.

Keywords: Data-driven control, Reference model, Controller identification, Estimate properties

1. Introduction

In the past two decades, a number of data-driven (DD) control design methods have been proposed [1, 2, 3, 4], where a parametrized controller structure is chosen a priori, and the controller tuning is based directly on input and output data collected on the plant without the use of a model of this plant. These methods are typically based on the Model Reference (MR) paradigm, in which the desired closed-loop performance is specified by means of a target closed-loop transfer function - the Reference Model. Some of these methods, like Iterative Feedback Tuning [1, 2] and Correlation-based Tuning (CbT) [4] are iterative in nature: the optimal controller is obtained as a sequence of controllers that operate on the actual plant, and experimental data are collected on the corresponding sequence of closed-loop plants. Other methods are "one-shot" - that is, non-iterative: they directly estimate the controller parameters on the basis of only one batch of input-output data; Virtual Reference Feedback Tuning (VRFT) [3] and a non-iterative version of

This work is supported by the Brazilian Ministry of Education through CAPES, by the Brazilian National Council for Research and Development - CNPq - and by the DYSCO network funded by the Belgian Programme on Interuniversity Attraction Poles, initiated by the Belgian Federal Science Policy Office.

Email address: luciola@ece.ufrgs.br (L. Campestrini)

CbT [5] are representative of this class. A common theoretical framework for these data-driven methods is provided in [6].

In this paper we present a new “one-shot” DD control design methodology, which is also based on the Model Reference paradigm. In our method the input-output model of the system is replaced from the outset by an equivalent input-output description involving only parameters of the controller. With this new parametrization, the estimation of the controller parameters is embedded in a completely standard Prediction Error (PE) identification problem, in which the inverse of the controller is identified. As a consequence, a complete statistical analysis of the estimated controller can be provided. An immediate consequence of PE identification theory is that the ideal model reference controller can be identified without bias if the controller structure chosen for the controller is of full order,¹ provided that open-loop data are used. The same holds with closed-loop data provided that a full order noise model is also identified. In the non-ideal case where the controller structure is not of full order (that is, the specified performance can only be approximated with this controller structure), the standard results from PE identification can be used to characterize the bias of the resulting controller.

An inherent property of the MR framework is the existence of an a priori algebraic relationship between the unknown plant, the known reference model, and the ideal controller (the one that would provide exactly the desired closed-loop performance). A similar relationship exists between the known reference model, a parametric model of the plant, and the parametric controller that would provide the desired closed-loop performance with this model. A major contribution of this paper, in which the controller rather than the model is identified, is to show that the existence of this relationship and of the desired reference model allows us to propose a range of possible design choices for the parametrization of the controller. These different design choices consist of incorporating different levels of prior knowledge about the ideal controller in a fixed part of the controller structure, resulting in a parametric part of varying complexity. In other words, the parametric part of the controller, which needs to be estimated by prediction error identification, will have different numbers of parameters depending on the design choices. These design choices can then be made to shape the bias and variance of the controller estimate, since bias and variance error depend very much on the flexibility of the controller structure, i.e. on the number of its parameters. Exploring these design choices and the resulting statistical properties for each one also provides a framework that allows a meaningful comparison of DD design with model-based design. With this comparison we show that indirect controller design - that is, plant identification followed by model-based MR design - can be seen as a particular case of our design method, in which all available prior knowledge of the ideal controller is included in the design. We also show that this particular design choice is the one that gives the least variance error, whereas the least bias error is provided by the opposite choice, in which no prior knowledge is included. In the practical case of undermodeling, where the controller set does not contain the ideal controller that would produce the ideal reference model, the bias error dominates the variance error. In such case, our simulations show that the DD design where no prior knowledge is included in the controller, thus allowing maximal parameter flexibility for bias shaping, also tends to provide the best average performance, but intermediate choices may be advisable. Thus, this statistical analysis also makes possible an educated choice of the parameters to be fixed.

The paper is organized as follows. Definitions and the problem formulation are presented in Section 2. Section 3 presents the proposed controller tuning method - the OCI, providing the properties of the resulting parameter estimates, as well as the design choices and their consequences in terms of bias and variance. A detailed simulation case study is presented in Section 4 to illustrate the application of the proposed method and the design choices. Experimental results in Section 5 show the effectiveness of the design methodology and the properties of each design choice in a practical setting. Conclusions are presented at the end of the paper.

¹That is, if it is possible to achieve exactly the specified performance with this structure.

2. Preliminaries

2.1. Background and Definitions

Consider a linear time-invariant discrete-time single-input-single-output process

$$y(t) = G_0(z)u(t) + v(t) = G_0(z)u(t) + H_0(z)e(t), \quad (1)$$

where z is the forward-shift operator, $G_0(z)$ is the process transfer function, $u(t)$ is the control input, $H_0(z)$ is the noise model, and $e(t)$ is zero mean white noise with variance σ_e^2 . Both transfer functions, $G_0(z)$ and $H_0(z)$, are rational. $G_0(z)$ is causal, while $H_0(z)$ is causal but not strictly causal, with $H_0(\infty) = 1$.

This process is controlled by a linear and time-invariant controller that belongs to a pre-specified class of controllers, parametrized in terms of a vector parameter $\rho \in \mathcal{D}_\rho \subseteq \mathbb{R}^d$, where \mathcal{D}_ρ is a set of admissible parameters. Specifically, the controller transfer function is $C(z, \rho)$ and the class is defined as $C = \{C(z, \rho) : \rho \in \mathcal{D}_\rho \subseteq \mathbb{R}^d\}$. The design task is to tune the parameter vector ρ in order to achieve the desired closed-loop performance.

We assume that the controller class C is such that $C(z, \rho)G_0(z)$ has positive relative degree for all $C(z, \rho) \in C$; equivalently, the closed loop is not delay-free. The control action $u(t)$ can be written as

$$u(t) = C(z, \rho)(r(t) - y(t)), \quad (2)$$

where $r(t)$ is a reference signal, which is assumed to be quasi-stationary and uncorrelated with the noise, that is $\bar{E}[r(t)e(s)] = 0 \forall t, s$, and

$$\bar{E}[f(t)] \triangleq \lim_{N \rightarrow \infty} \frac{1}{N} \sum_{t=1}^N E[f(t)]$$

with $E[\cdot]$ denoting expectation [7]. The system (1)-(2) in closed loop becomes

$$\begin{aligned} y(t, \rho) &= T(z, \rho)r(t) + S(z, \rho)v(t) \\ T(z, \rho) &= \frac{C(z, \rho)G_0(z)}{1 + C(z, \rho)G_0(z)} = C(z, \rho)G_0(z)S(z, \rho) \end{aligned}$$

where we have now made the dependence on the controller parameter vector ρ explicit in the output signal $y(t, \rho)$.

2.2. Model reference Control

Model Reference control design consists of specifying the desired closed-loop transfer function $M(z)$, which is known as the *reference model*, and then solving the following optimization problem for a specified reference signal $r(t)$:

$$\min_{\rho} J^{MR}(\rho) \quad (3)$$

$$J^{MR}(\rho) \triangleq \bar{E} \left[\left(\frac{C(z, \rho)G_0(z)}{1 + C(z, \rho)G_0(z)} - M(z) \right) r(t) \right]^2 \quad (4)$$

$$s.t. \quad C(z, \rho) \in C. \quad (5)$$

The *optimal controller* is defined as $C(z, \rho^{MR})$ with ρ^{MR} the solution of the problem (3)-(4)-(5). We assume that the user can collect a batch of data from the process (1)

$$Z^N = [u(1), y(1), \dots, u(N), y(N)].$$

His/her task is then to estimate the *optimal parameters* of the controller $C(z, \rho^{MR})$ from these data.

Analyzing (4) we see that if the *ideal controller*

$$C_d(z) \triangleq \frac{M(z)}{G_0(z)(1 - M(z))} \quad (6)$$

were used in the closed loop then the objective function (3) would evaluate to zero. However, this ideal controller may not correspond to any controller in the controller set \mathcal{C} ; actually in most practical applications it will not belong to \mathcal{C} . For our further analysis, we will sometimes consider the situation where $C_d(z) \in \mathcal{C}$, in which case we shall say that the following assumption holds.

Assumption 1. Matching condition

$$\exists \rho_0 \in D_\rho \text{ such that } C(z, \rho_0) = C_d(z).$$

3. Optimal Controller Identification - OCI

3.1. A data-based design method

By using the concept of the ideal controller, it is possible to turn the model reference control design problem into an identification problem. In so doing, a specific data-based design method is obtained [8]. The core idea is to rewrite the input-output system (1) in terms of the ideal controller $C_d(z)$, which is done by inverting the relation (6), i.e.

$$G_0(z) = \frac{1}{C_d(z)} \frac{M(z)}{1 - M(z)}. \quad (7)$$

Then a model for the plant can be written in terms of the controller parameters as

$$G(z, \rho) \triangleq \frac{1}{C(z, \rho)} \frac{M(z)}{1 - M(z)}$$

and the task will be to identify an estimate $C(z, \hat{\rho})$ of the ideal controller $C_d(z)$ within the parametrized controller class defined by the set of controllers $\mathcal{C} = \{C(z, \rho), \rho \in \mathcal{D}_\rho \subseteq \mathbb{R}^d\}$.

It is often the case that one imposes some fixed part in the controller, the most common instance of this fact probably being the imposition of a pole at $z = 1$ to guarantee zero steady-state error for constant references and perturbations. This fixed part does not need to be identified. So, we call $C^F(z)$ this fixed part and rewrite the controller transfer function as

$$C(z, \rho) = C^I(z, \rho) C^F(z) \quad (8)$$

where, to make this factorization unique and to facilitate the embedding of our problem into the PE framework, we assume that the **numerator** of $C^I(z, \rho)$ is a monic polynomial.

Now define

$$\tilde{C}(z, \rho) \triangleq \frac{1}{C^I(z, \rho)} = \frac{C^F(z)}{C(z, \rho)}, \quad (9)$$

so that the input-output model can be written as

$$\begin{aligned} y(t, \theta) &= \underbrace{\frac{1}{C^I(z, \rho)}}_{\tilde{C}(z, \rho)} \times \underbrace{\frac{M(z)}{C^F(z)(1 - M(z))}}_{\tilde{u}(t)} u(t) + H(z, \theta) e(t) \\ &= \tilde{C}(z, \rho) \tilde{u}(t) + H(z, \theta) e(t) \end{aligned} \quad (10)$$

where $\theta = [\rho^T \quad \eta^T]^T$ and $\eta \in \mathbb{R}^c$ is an additional parameter vector appearing in the noise model.

Example 1. Suppose that the controller class \mathcal{C} consists of the following

$$C(z, \rho) = \frac{z^2 + \rho_3 z + \rho_4}{(z - 1)(\rho_1 z + \rho_2)} \quad (11)$$

where the vector $\rho = [\rho_1 \ \rho_2 \ \rho_3 \ \rho_4]^T \in \mathbb{R}^4$ contains the parameters to be tuned. We choose the integrator as the fixed part and rewrite, from (11) and (8)

$$C^F(z) = \frac{1}{z-1}, \quad C^I(z, \rho) = \frac{z^2 + \rho_3 z + \rho_4}{\rho_1 z + \rho_2}.$$

Then the model structure to be identified in (10) will be

$$\tilde{C}(z, \rho) = \frac{\rho_1 z + \rho_2}{z^2 + \rho_3 z + \rho_4}$$

and we have recast the estimation of the controller in the standard PE framework, where the model structure $\tilde{C}(z, \rho)$ in (10) has a monic denominator.

Once the controller estimation problem has been rewritten as the identification of the inverse of part of the ideal controller in (10) the controller design proceeds as a standard identification procedure, as follows. From N measured input-output data one constructs the data vector

$$Z_c^N = [\tilde{u}(1), y(1), \dots, \tilde{u}(N), y(N)]$$

and then the estimate $\hat{\theta}_N = [\hat{\rho}_N^T \ \hat{\eta}_N^T]^T$ is given by

$$\hat{\theta}_N = \arg \min_{\theta} V(\theta) \quad (12)$$

where

$$V(\theta) = \sum_{t=1}^N \varepsilon^2(t, \theta),$$

$\varepsilon(t, \theta)$ is the prediction error

$$\varepsilon(t, \theta) \triangleq y(t) - \hat{y}(t|t-1, \theta), \quad (13)$$

and $\hat{y}(t|t-1, \theta)$ is the optimal one-step-ahead predictor for model (10):

$$\hat{y}(t|t-1, \theta) = H^{-1}(z, \theta) \tilde{C}(z, \rho) \tilde{u}(t) + [1 - H^{-1}(z, \theta)] y(t).$$

Using (8) and (9), the estimated optimal controller is then obtained by

$$C(z, \hat{\rho}_N) = \frac{1}{\tilde{C}(z, \hat{\rho}_N)} C^F(z). \quad (14)$$

So, instead of minimizing $J^{MR}(\rho)$, which depends on the unknown plant $G_0(z)$, the design is made by minimizing the cost function $V(\theta)$, which is purely data-dependent and no model of the plant $G_0(z)$ is used. It is worth mentioning that, since the object of interest is the optimal controller only, and not the plant model, the identification of $H_0(z)$ is of no interest *per se*.

Since the estimation of the optimal MR controller has been transformed into a PE identification problem, all properties of PE identification theory apply. Specifically, with open-loop data, the estimate in (12) converges to the vector θ^* defined as follows:

$$\hat{\theta}_N \longrightarrow \theta^* = \arg \min_{\theta} \bar{V}(\theta) \quad (15)$$

with

$$\bar{V}(\theta) = \bar{E}[\varepsilon^2(t, \theta)] = \frac{1}{2\pi} \int_{-\pi}^{\pi} \frac{1}{|H(e^{j\omega}, \theta)|^2} \{ |\tilde{C}_d(e^{j\omega}) - \tilde{C}(e^{j\omega}, \rho)|^2 \Phi_{\tilde{u}}(\omega) + \Phi_v(\omega) \} d\omega, \quad (16)$$

where $\tilde{C}_d(z) \triangleq \frac{C^F(z)}{C_d(z)}$, $\Phi_v(\omega)$ is the noise spectrum and $\Phi_{\tilde{u}}(\omega)$ is the spectrum of $\tilde{u}(t)$:

$$\Phi_{\tilde{u}}(\omega) = \frac{|M(e^{j\omega})|^2}{|C^F(e^{j\omega})(1 - M(e^{j\omega}))|^2} \Phi_u(\omega).$$

As will be demonstrated later, ρ^{MR} is a global minimum of $\bar{V}(\theta)$ under Assumption 1 and some excitation conditions on the data. When these assumptions are not satisfied, the minima of $\bar{V}(\theta)$ and $J^{MR}(\rho)$ are distinct. These minima could be made closer by a proper filter choice, as is done in the VRFT methodology, or by choosing a proper reference model. Satisfaction of Assumption 1 depends on both the controller class and the choice of reference model. It is known that if the user knows some characteristics of the plant, a reference model based on this knowledge is much more likely to be attained [6]. If the controller class is fixed, there is always a possibility of choosing a performance that is not too far from what can be achieved considering system limitations. For example, a PI controller will not be able to provide a settling time that is much faster than the open-loop response, except for the simplest plants. Considering this limitation when choosing the reference model will yield a situation where the chosen controller class is closer to the ideal controller. Guidelines on choices of the reference model such that the PID controller class is close to the ideal controller class are given in [6, 9].

3.2. Consistency of the OCI

In the case of a full order controller we can immediately state consistency results for the controller estimate, as corollaries of standard PE identification theory [7] applied to (10). To do this, we need to formalize an assumption on the data.

Assumption 2. *Input richness*

The filtered input $\bar{u}(t)$ is sufficiently rich to make the experiment informative with respect to the model structure defined by $\tilde{C}(z, \rho)$.

The reader is referred to [10] for the exact richness conditions required to provide informative experiments for arbitrary model structures.

The first consistency result concerns identification in open-loop and is a Corollary of Theorem 8.4 in [7].

Theorem 1. *Let Assumptions 1 and 2 be satisfied. Moreover, let the data $u(t)$ and $y(t)$ be collected in open loop and let $\tilde{C}(z, \rho)$ and $H(z, \theta)$ have disjoint parameters, that is, $\frac{\partial H(z, \theta)}{\partial \rho} \equiv \mathbf{0}$. Let $\hat{\theta}_N = [\hat{\rho}_N^T \hat{\eta}_N^T]^T$ be defined by (12). Then $\hat{\rho}_N \rightarrow \rho_0$ when $N \rightarrow \infty$, i.e. with $C(z, \hat{\rho}_N)$ defined by (14) we have*

$$C(z, \hat{\rho}_N) \rightarrow C_d(z).$$

The same properties hold if the data are collected in closed loop, and if in addition the noise model is also capable of representing exactly the true noise $H_0(z)$. This is formalized in the following result, which is a Corollary of Theorem 8.3 in [7].

Theorem 2. *Let Assumptions 1 and 2 be satisfied. Moreover, let the data $u(t)$ and $y(t)$ be collected in closed loop and assume that $\exists \theta_0$ such that $H(z, \theta_0) = H_0(z)$, with $\theta_0 = [\rho_0^T \ \eta_0^T]^T$. Let $\hat{\theta}_N = [\hat{\rho}_N^T \ \hat{\eta}_N^T]^T$ be defined by (12). Then $\hat{\theta}_N \rightarrow \theta_0$ when $N \rightarrow \infty$, i.e. with $C(z, \hat{\rho}_N)$ defined by (14) we have*

$$C(z, \hat{\rho}_N) \rightarrow C_d(z)$$

and

$$H(z, \hat{\theta}_N) \rightarrow H_0(z).$$

It is important to notice that these consistency properties are valid regardless of the choice of $C^F(z)$. Also fundamental is the concept, familiar to the most known DD one-shot methods [11, 12, 13]: because $J^{MR}(\rho)$ is hard to optimize and depends on the unknown true plant, we minimize another function (in our case $V(\theta)$) which is purely data-dependent, easier to minimize and which, under ideal conditions, has the same global minimum as $J^{MR}(\rho)$. But unlike the literature one-shot methods, OCI does not resort to instrumental variables to deal with the noise.

3.3. The fixed part $C^F(z)$

Given the freedom in the choice of the fixed part $C^F(z)$ of the controller, we shall in this section discuss some important design choices of the method and the corresponding properties of the resulting controller. We do so mainly by examining the connections between the poles and zeroes of the real system $G_0(z)$, the reference model $M(z)$ and the ideal controller $C_d(z)$. From (6) we have that

$$C_d(z) = \frac{d_{G_0}(z)n_M(z)}{n_{G_0}(z)(d_M(z) - n_M(z))}, \quad (17)$$

where $n_F(z)$ denotes the numerator of a transfer function $F(z)$ and $d_F(z)$ its denominator. **Should we not include the following, which we had in the Automatica version of 2012? We consider the case where there are no exact cancellations between n_{G_0} and n_M , or between d_{G_0} and $(d_M - n_M)$, because such cancellations would amount to prior knowledge of parts of G_0 . We (Luciola and Diego) don't understand what we gain by adding this sentence. In the NMP case, we need this cancellation to obtain a stable ideal controller. This also happens with the delay of the process, that we have to include in the reference model to obtain a causal ideal controller.**

It follows from (17) that there are several possibilities to factor $C(z, \rho)$ into a fixed part and a part to be identified. Since $M(z)$ is known, one extreme possibility is to take $C^F(z) = \frac{n_M(z)}{d_M(z) - n_M(z)}$ as the fixed part of the parametric controller structure (8). By doing this, one gets $\tilde{u}(t) = u(t)$ and $\tilde{C}_d(z) = G_0(z)$ in (10), and the problem is then reduced to the identification of $G_0(z)$ and the computation of the controller via (6) in which $G_0(z)$ is replaced by the identified $G(z, \hat{\rho}_N)$. In other words, this amounts to model identification plus model-based control based on the certainty equivalence principle, usually called indirect control design in the adaptive control literature.

Another extreme is to leave all parameters free. In the latter case, the vector ρ will contain more parameters than in the former case, which gives the algorithm more degrees of freedom when minimizing the cost function. In between these two extreme choices, the fixed part $C^F(z)$ may contain any fraction of the known transfer function $\frac{n_M(z)}{d_M(z) - n_M(z)}$, in which case the parametric model structure $\tilde{C}(z, \rho)$ will take the form

$$\tilde{C}(z, \rho) = \frac{n_G(z, \rho)d_P(z, \rho)}{d_G(z, \rho)n_P(z, \rho)}, \quad (18)$$

where n_P and d_P are the fractions of n_M and $(d_M - n_M)$, respectively, that the user has chosen to put in $\tilde{C}(z, \rho)$. Fixing parts of $C^F(z)$ may be called for to account for characteristics not explicitly apparent in the mathematical formulation, such as the inclusion of an exact integrator in the controller (an ubiquitous practical requirement).

Observe that by choosing different structures for $C^F(z)$ we are able to perform model-based control – when $C^F(z) = \frac{n_M(z)}{d_M(z) - n_M(z)}$ – or data-driven control for any other choice for $C^F(z)$, both using the PEI methodology. By doing this, we believe that a fair comparison can be done between model-based and data-driven control methods.

Besides, different choices of $C^F(z)$ result in different statistical properties of the estimate, which will be discussed in the next section.

3.4. Estimate error

The error between the ideal controller and the estimated controller is given by

$$C_d(z) - C(z, \hat{\rho}_N) = \underbrace{(C_d(z) - C(z, \rho^*))}_{\text{BIAS}} + \underbrace{(C(z, \rho^*) - C(z, \hat{\rho}_N))}_{\text{VARIANCE}}. \quad (19)$$

Since the main goal is to identify $C_d(z)$, the choice of $C^F(z)$ can be done in order to minimize this error. First of all, when Assumption 1 holds, the bias term is zero and there is only the variance error. That the identification of more parameters results in larger variance of the estimated transfer function is known from [14] [15]. So, in this case it is indicated to have the smallest possible size for ρ in order to have the smallest

variance for the estimated controller transfer function. This is achieved by letting the degree of the fixed part $C_F(z)$ be as large as possible in the factorization (8). It corresponds to the choice $C^F(z) = \frac{n_M(z)}{d_M(z)-n_M(z)}$, resulting in model-based control as discussed above. Any other choice for the fixed part of the controller, which configures a data-driven approach, yields more parameters to be identified, resulting in larger variance in the controller, as was also shown in [8].

When Assumption 1 does not hold, the estimated controller will have a bias and a variance error, and the bias term will typically be significant. As the size of the vector ρ is increased, so does the complexity (and hence the flexibility) of the controller, and the better this controller will be able to approximate the ideal controller $C_d(z)$, thus reducing the bias error. Thus, the bias can be shaped by not restricting the controller class, that is by not imposing too many constraints in $C^F(z)$. Choosing $C^F(z) = 1$ will minimize the bias, at the expense of an increase in the variance error.

In a practical situation, one wants to reduce the total error (19). So a compromise must be reached between the two extreme choices for $C^F(z)$. For a given McMillan degree of the controller $C(z, \rho)$, choosing $C^F(z) = \frac{n_M(z)}{d_M(z)-n_M(z)}$ implies a small size for the parameter ρ and hence a large bias error and a small variance error for the estimate of $\tilde{C}(z, \rho)$ (see (8)-(9)). At the other extreme, choosing $C^F(z) = 1$ implies a flexible controller $\tilde{C}(z, \rho)$ with a parameter vector ρ of large size, resulting in a small bias error and a large variance error.

4. A case study

In this section, we present an example that illustrates the design choices for the definition of the fixed part of the controller and the properties that result for these different design choices. We successively consider the case where the ideal controller belongs to the controller class \mathcal{C} and the case where it does not. For both cases, we consider that the system is described by (1) with

$$G_0(z) = \frac{0.5(z-0.8)}{(z-0.7)(z-0.9)}, \quad H_0(z) = \frac{z}{z-0.3}, \quad (20)$$

and that the white noise variance is $\sigma_e^2 = 0.01$. The desired reference model with zero steady-state error is chosen as:

$$M(z) = \frac{0.16z}{(z-0.6)^2}.$$

The ideal controller is then calculated from (6) as

$$C_d(z) = \frac{0.32z(z-0.7)(z-0.9)}{(z-0.8)(z-1)(z-0.36)}$$

In order to compare the properties of the estimates corresponding to the different choices for $C^F(z)$, we identified the controllers under the following experimental conditions. We applied a PRBS signal with amplitude ± 1 as input signal of an open-loop experiment, and we collected 1000 samples of input and output data on the process. The identification was done using output error structures and the use of the algorithm presented in [16]. The identification toolbox with the algorithm can be found in <http://www.datadrivencontrol.com>. The use of an output error model, i.e. with $H(z, \theta) = 1$ still results in an unbiased estimate for the controller since the data are collected in open loop.

One hundred Monte Carlo runs were realized for each choice for $C^F(z)$; an error measure, denoted by E , was computed for each controller as

$$E = \left\| \frac{z-1}{z} [C_d(z) - C(z, \hat{\rho}_N)] \right\|_2,$$

where we have removed the unstable modes from the controller to obtain a finite value. In the case where the matching condition is satisfied, this error is made of a variance error only, while in the case where the matching condition is not satisfied, this measure contains both variance and bias error.

We have applied all the controllers to a closed-loop system without noise, so that we could also evaluate the reference model cost as

$$\hat{J} = \frac{1}{N} \sum_{t=1}^N (y(t, \hat{\rho}_N) - y_d(t))^2 = \frac{1}{N} \sum_{t=1}^N [(T(z, \hat{\rho}_N) - M(z))r(t)]^2,$$

where the reference signal $r(t)$ applied to the closed loop is a square wave with amplitude 1 and period 200 samples, during $N = 1000$ samples.

4.1. The ideal case: $C_d(z) \in C$

We first select a controller structure $C = \{C(z, \rho)\}$ that is able to represent the ideal $C_d(z)$. It is clear from (8) that at least two extreme choices are possible for $C^F(z)$:

$$C_1^F(z) = \frac{M(z)}{1 - M(z)} \quad \text{or} \quad C_4^F(z) = 1.$$

With the first choice we fix everything we know from the ideal controller, which yields

$$C_1^F(z) = \frac{0.16z}{(z-1)(z-0.36)}, \quad C_1^I(z, \rho) = \frac{z^2 + \rho_3z + \rho_4}{\rho_1z + \rho_2}, \quad \text{and hence} \quad \tilde{C}(z, \rho) = \frac{\rho_1z + \rho_2}{z^2 + \rho_3z + \rho_4}$$

with $\rho_{0_1} = [0.5 \quad -0.4 \quad -1.6 \quad 0.63]^T$, while in the second choice we do not fix anything and let the algorithm identify all the parameters of the controller, that is

$$C_4^F(z) = 1 \quad \text{and} \quad C_4^I(z, \rho) = \frac{z^3 + \rho_5z^2 + \rho_6z + \rho_7}{\rho_1z^3 + \rho_2z^2 + \rho_3z + \rho_4},$$

with the optimal $\rho_{0_4} = [3.125 \quad -6.75 \quad 4.525 \quad -0.9 \quad -1.6 \quad 0.63 \quad 0]^T$. Thus we observe that the second choice leads to the estimation of seven parameters, while the first leads to the estimation of only four parameters which are in fact the parameters of $G_0(z)$, as explained in Section 3.

In between these two extreme choices, there is the possibility of choosing different structures for the fixed part of the controller, such as an integrator for the case where one control objective is to follow constant signals, for example. For this case, we show the results using also two intermediate choices, given by

$$C_2^F(z) = \frac{z}{z-1} \quad \text{and} \quad C_3^F(z) = \frac{1}{z-1}.$$

Using $C_2^F(z)$ yields

$$C_2^I(z, \rho) = \frac{z^2 + \rho_4z + \rho_5}{\rho_1z^2 + \rho_2z + \rho_3},$$

with $\rho_{0_2} = [3.125 \quad -3.625 \quad 0.9 \quad -1.6 \quad 0.63]^T$, while using $C_3^F(z)$ results in

$$C_3^I(z, \rho) = \frac{z^3 + \rho_4z^2 + \rho_5z + \rho_6}{\rho_1z^2 + \rho_2z + \rho_3},$$

with $\rho_{0_3} = [3.125 \quad -3.625 \quad 0.9 \quad -1.6 \quad 0.63 \quad 0]^T$.

Fig. 1 shows the box plots² of the error measure E resulting from 100 Monte Carlo runs for each of the four different choices for $C^F(z)$ ³. From Fig. 1 we see that as we increase the number of identified parameters, the error E increases. Since $C_d(z) \in C$, this error is due only to the parameter variance error. Thus the error on the estimated controller increases with the number of parameters, since more parameters

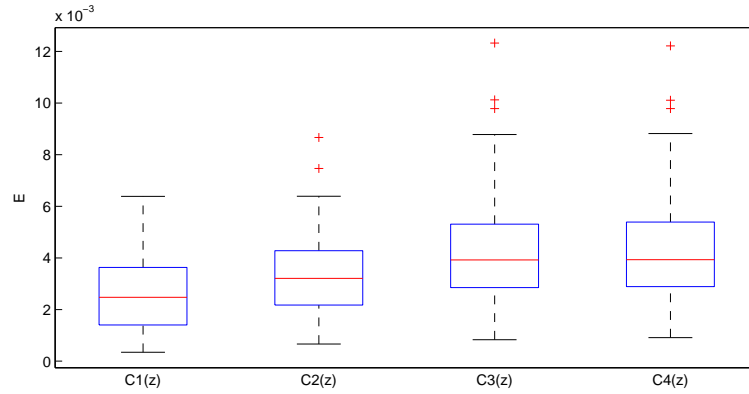

Fig. 1. Distribution of the error measure E considering the 100 Monte Carlo runs for each choice of $C^F(z)$ in the case Assumption 1 is satisfied.

result in larger variance error. Fig. 2 shows the box plots of the estimated cost \hat{J} , for the four different choices for the fixed part of the controller, while Table 1 shows the mean value of the estimated control error E and of the estimated cost \hat{J} for these four different choices of $C_F(z)$. We observe that, even though the controller variance increases significantly with the number of free parameters, the increase in the achieved model reference cost is much smaller. To be precise, Table 1 shows that the average control error E increases by 58% between the configurations $C_1^F(z)$ and $C_4^F(z)$, while the corresponding increase for \hat{J} is only 21%. We conclude that in the case where the ideal controller belongs to the controller set \mathcal{C} , model-based design is to be preferred because it yields an estimation problem with the smallest number of parameters and that the only errors are due to variance.

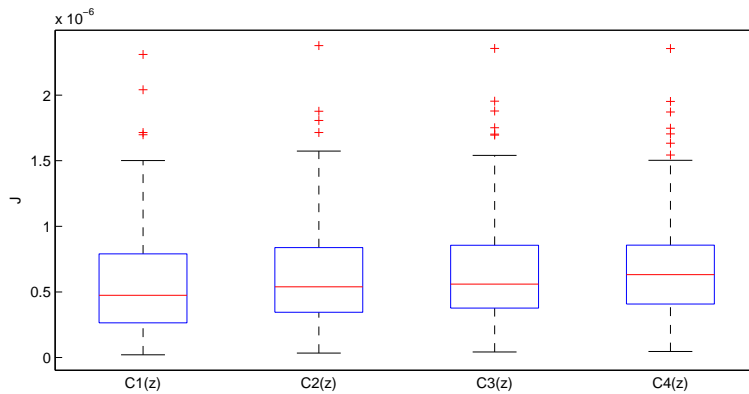

Fig. 2. Distribution of the estimated cost \hat{J} considering the 100 Monte Carlo runs for each choice of $C^F(z)$ in the case Assumption 1 is satisfied.

For each choice for $C^F(z)$, the mean controllers were obtained from the 100 Monte Carlo runs, which

²On each box, the central mark is the median, the edges of the box are the 25th and the 75th percentiles, the whiskers extend to the most extreme data points not considered outliers, and outliers are plotted individually.

³With the choice $C_4^F(z)$, the integrator is identified with some variance error. In order to compute the error measure, we considered rounding the integrator with a 10^{-4} tolerance.

Table 1. Mean values of E and \hat{J} in the case Assumption 1 is satisfied.

Controller	Mean error	Mean cost
$C_1^F(z)$	2.6460×10^{-3}	5.7324×10^{-7}
$C_2^F(z)$	3.2942×10^{-3}	6.4631×10^{-7}
$C_3^F(z)$	4.1849×10^{-3}	6.7400×10^{-7}
$C_4^F(z)$	4.1877×10^{-3}	6.9633×10^{-7}

are given by

$$\begin{aligned}
C_1(z, \hat{\rho}_m) &= \frac{1.9989(z - 0.9003)(z - 0.7008)}{(z - 0.8010)} \frac{\mathbf{0.16z}}{(z - \mathbf{1})(z - \mathbf{0.36})}, \\
C_2(z, \hat{\rho}_m) &= \frac{0.31977(z - 0.9005)(z - 0.7031)}{(z - 0.8025)(z - 0.3614)} \frac{z}{z - \mathbf{1}}, \\
C_3(z, \hat{\rho}_m) &= \frac{0.31976(z - 0.9006)(z - 0.7031)(z + 0.0006482)}{(z - 0.8027)(z - 0.3607)} \frac{\mathbf{1}}{z - \mathbf{1}}, \\
C_4(z, \hat{\rho}_m) &= \frac{0.31975(z - 0.9005)(z - 0.7023)(z + 0.0009422)}{(z - 1.000)(z - 0.8021)(z - 0.3602)} \mathbf{1},
\end{aligned}$$

where the fixed part is clearly separated from the identified part of the controller.

From Fig. 1 and Table 1 we see that the choices $C_3^F(z)$ and $C_4^F(z)$ yield essentially the same results for the norm of the control error and for the achieved control cost. **However, fixing a pole at 1 guarantees null steady-state error to step changes, and for this reason, we consider only choices where this pole is fixed.** We have tested situations where the noise was high ($\sigma = 1$) and $C^F = 1$ and actually the integrator is always estimated with low variance: sometimes OCI estimates unstable poles, like at 1.0005, but the closed-loop with this controller is stable and the steady-state error is not null, but low. For this reason, we changed the text above.

4.2. The non-ideal case: $C_d(z) \notin \mathcal{C}$

We now explore the application of the OCI method considering that the chosen controller structure is restricted and that $C_d(z)$ does not belong to it. We still consider different choices for $C^F(z)$, and the corresponding $C^I(z)$ contains less parameters than would be necessary to identify the ideal controller. Our choices are as follows:

$$C_1^F(z) = \frac{0.16z}{(z - 1)(z - 0.36)}, \quad C_1^I(z, \rho) = \frac{z + \rho_2}{\rho_1} \quad (21)$$

$$C_2^F(z) = \frac{z}{z - 1}, \quad C_2^I(z, \rho) = \frac{z + \rho_3}{\rho_1 z + \rho_2} \quad (22)$$

$$C_3^F(z) = \frac{1}{z - 1}, \quad C_3^I(z, \rho) = \frac{z^2 + \rho_3 z + \rho_4}{\rho_1 z + \rho_2}. \quad (23)$$

Notice that the first choice corresponds to the model-based approach, where we identify a first order model for the plant, which is actually second order. Choices 2 and 3 correspond to data-driven approaches, with different degrees of freedom for the part to be identified.

Again, 100 Monte Carlo runs were performed, and for each obtained controller the error measure E and the reference model cost \hat{J} were computed. Notice that now the error measure E is formed by variance and bias errors. Fig. 3 shows the error measure E for each obtained controller, while Fig. 5 shows the obtained cost when each controller was applied in closed loop (considering a noise free experiment, to evaluate the reference model cost). From Fig. 3 we see that the more free parameters to estimate, the smaller is the error E , showing that the bias error dominates the variance error. There is no significant difference between

choices 2 and 3, but it is significant when comparing these two to the first choice, namely the model-based design. The distribution of this measure is shown in Fig. 4, where we can see that the median of $C_3^F(z)$ is slightly smaller than the median of $C_2^F(z)$. The mean values of E for the three choices are presented in Table 2.

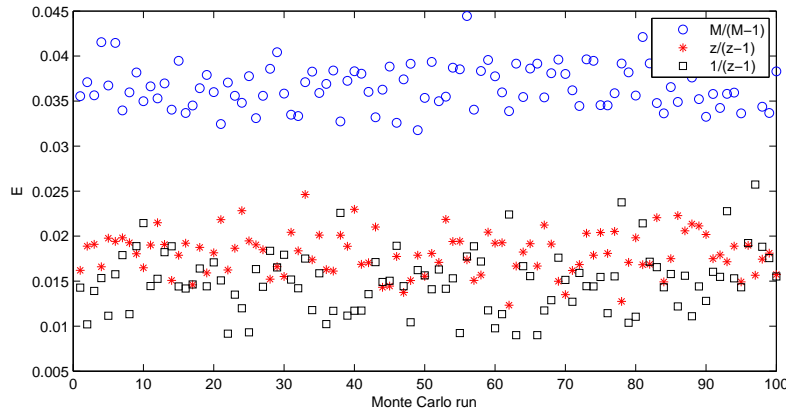

Fig. 3. Error measure E for the 100 Monte Carlo runs for each choice of $C^F(z)$ when Assumption 1 is not satisfied.

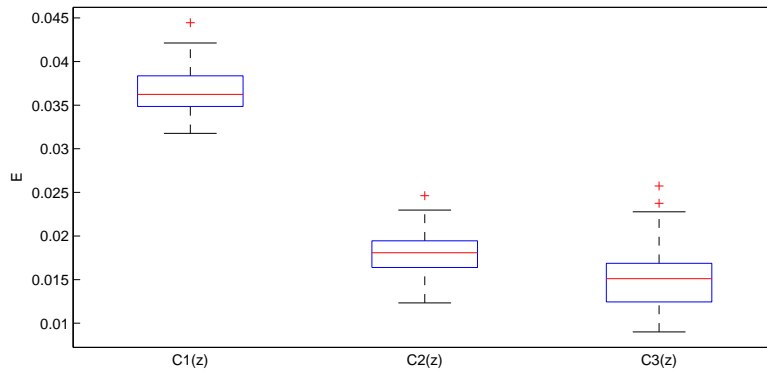
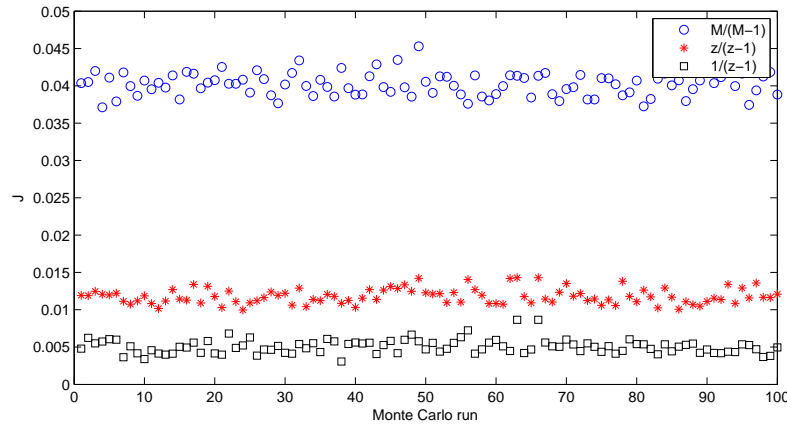

Fig. 4. Distribution of the error measure E for the 100 Monte Carlo runs for each choice of $C^F(z)$ in the case Assumption 1 is not satisfied.

However, when we consider the reference model cost $\hat{J}^{MR}(\rho)$, which is actually our performance criterion, there is a significant difference between the three different choices: the more parameters we estimate, the smaller is the resulting cost, as shown in Fig. 5. This is an important observation which shows that, in a practical situation where the ideal controller does not belong to the chosen controller class, the bias error dominates. Thus bias error is reduced when we perform data-driven design using more free parameters, i.e. when more degrees of freedom are available for the minimization of the cost function. Notice that our method does not minimize $J^{MR}(\rho)$ cost, but minimizes $\hat{V}(\theta)$, which does not depend on the process model. However, we can see that by minimizing $\hat{V}(\theta)$, we have also minimized $J^{MR}(\rho)$, as shown by the results presented in Fig. 5, where the calculated cost is presented for each Monte Carlo run, as well as in Figs. 6 and 7, where the distribution of the calculated cost is presented with box and histograms plots, respectively. The mean values of the cost \hat{J} are also presented in Table 2, where it is seen that they have significantly decreased with more free parameters.

Table 2. Mean values of E and \hat{J} when Assumption 1 is not satisfied.

Controller	Mean error	Mean cost
$C_1^F(z)$	3.6653×10^{-2}	4.0181×10^{-2}
$C_2^F(z)$	1.8061×10^{-2}	1.1804×10^{-2}
$C_3^F(z)$	1.5036×10^{-2}	5.0596×10^{-3}

Fig. 5. Estimated cost \hat{J} for the 100 Monte Carlo runs for each choice of $C^F(z)$ in the case Assumption 1 is not satisfied.

We have also computed the mean value of each controller. For each choice of $C^F(z)$, the mean controllers, from the 100 Monte Carlo runs, are given by

$$\begin{aligned}
 C_1(z, \hat{\rho}_m) &= \frac{2.1439(z - 0.8499)}{1} \frac{\mathbf{0.16z}}{(z - \mathbf{1})(z - \mathbf{0.36})}, \\
 C_2(z, \hat{\rho}_m) &= \frac{0.31607(z - 0.8705)}{(z - 0.4721)} \frac{\mathbf{z}}{z - \mathbf{1}}, \\
 C_3(z, \hat{\rho}_m) &= \frac{0.32116(z - 0.8796)(z - 0.1479)}{(z - 0.5692)} \frac{\mathbf{1}}{z - \mathbf{1}}.
 \end{aligned}$$

5. Experimental results

We have applied the proposed methodology to design a PID controller of a pilot plant, where the goal is to control the level of one tank in a three tank plant. The same plant was used in [6], where a controller was obtained using the VRFT method considering the flow control of one tank. The schematic diagram in Fig. 8 describes the main parts of the process. The whole process is built with of-the-shelf industrial equipment (pumps, valves, sensors and tanks). Tanks 1 and 2 have a 70 liters capacity each, while tank 3 is a 250 liter container.

The water is pumped up from Tank 3 to Tank 2 through Valve 1, from Tank 1 to Tank 2 through Valve 2 and back to Tank 3 by gravity. The liquid level of Tank 1 is the process variable $y(t)$ and the opening of Valve 1 is the manipulated variable $u(t)$. Our goal here is to apply the OCI methodology for the computation of controllers to obtain a desired closed-loop performance, with two choices for $C^F(z)$. One choice is related to model based control and other to data-driven control. Data were collected in an open-loop experiment in which the input was a square, wave over 5000 s, where the sampling time was $T_s = 10$ s. The input and output signals of the experiment are presented in Fig. 9.

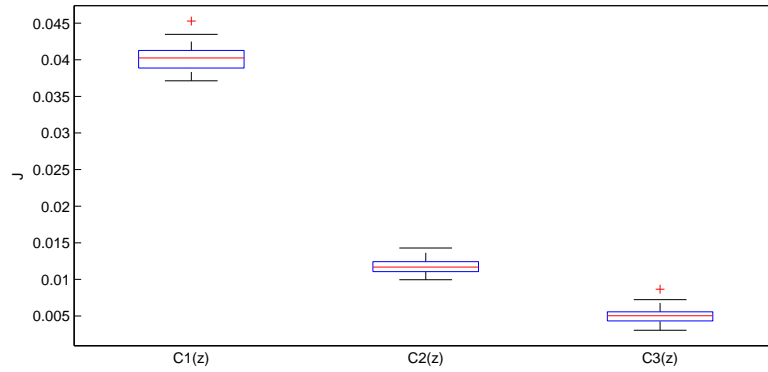

Fig. 6. Distribution of the estimated cost \hat{J} for the 100 Monte Carlo runs for each choice of $C^F(z)$ in the case Assumption 1 is not satisfied.

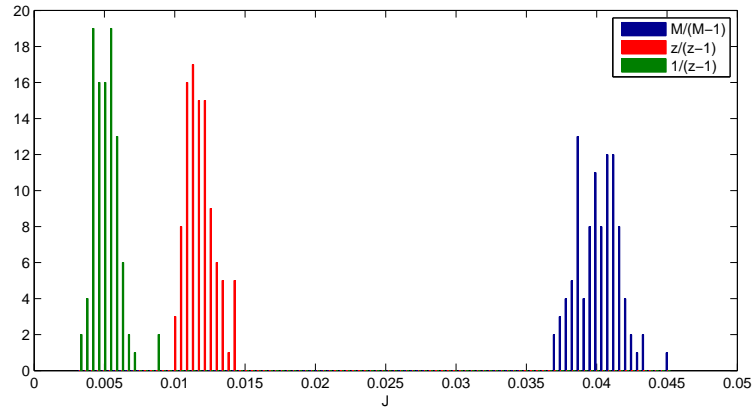

Fig. 7. Histogram of the estimated cost \hat{J} for the 100 Monte Carlo runs for each choice of $C^F(z)$ in the case Assumption 1 is not satisfied.

The open-loop settling time is around 800 s, and since the process dynamics involves the dynamics of two tanks, we have chosen a reference model with two poles and settling time around 400 s, given by

$$M(z) = \frac{0.0169z}{(z - 0.87)^2}.$$

To apply the OCI method, we need to define, among the PID controller class, the fixed part of the controller. In order to show what we have explored in the paper, we defined two different controllers:

$$C_1^F(z) = \frac{M(z)}{(1 - M(z))} = \frac{0.0169z}{(z - 1)(z - 0.7569)}, \quad C_1^I(z, \rho) = \frac{z + \rho_2}{\rho_1} \quad (24)$$

$$C_2^F(z) = \frac{1}{z - 1}, \quad C_2^I(z, \rho) = \frac{z^2 + \rho_3z + \rho_4}{\rho_{1z} + \rho_2}. \quad (25)$$

With $C_1^F(z)$, OCI leads to a plant model of order one, followed by the computation of the controller, while with the choice of $C_2^F(z)$ only a pole at one is fixed and two additional parameters are used in order to estimate the controller. Notice that a first order model for the plant is clearly an underparameterized model,

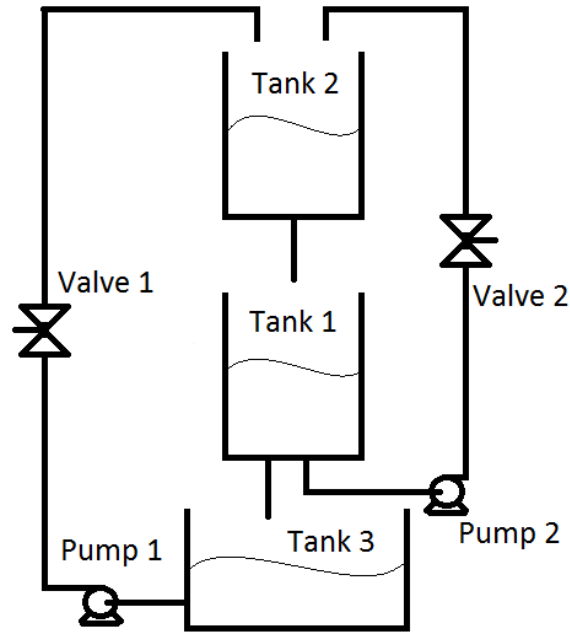

Fig. 8. Schematic diagram of the pilot plant.

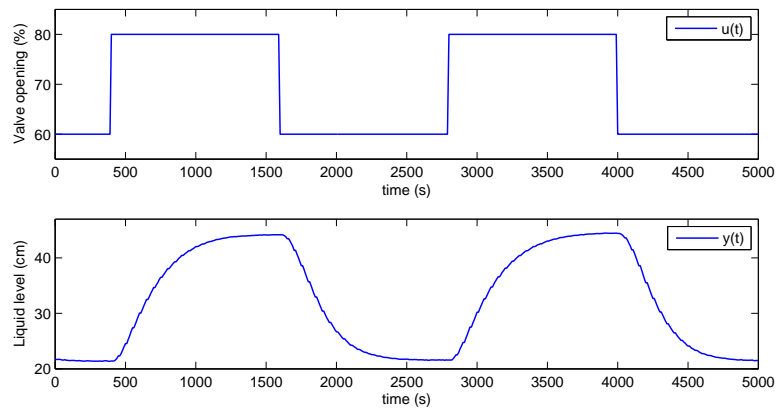

Fig. 9. Open-loop experiment.

since the real plant involves the dynamics of two tanks. The resulting controllers are

$$C_1(z, \hat{\rho}_N) = 27.588(z - 0.96953) \frac{0.0169z}{(z - 1)(z - 0.7569)} \quad (26)$$

$$C_2(z, \hat{\rho}_N) = \frac{6.8237(z^2 - 1.8759z + 0.88012)}{(z - 0.5293)} \frac{1}{z - 1}, \quad (27)$$

and the closed-loop responses obtained with both controllers are presented in Fig. 10. The estimated cost

$$\hat{J} = \frac{1}{N} \sum_{t=1}^N (y(t, \hat{\rho}_N) - y_d(t))^2$$

was computed as 2.0358 cm^2 for the closed loop with $C_1(z, \hat{\rho}_N)$ and 0.12789 cm^2 for the closed loop with $C_2(z, \hat{\rho}_N)$, using data presented in Fig. 10. Notice that, unlike the simulated results presented in the previous section, this cost is not the model reference cost, since the collected output is noisy, but it is formed by the model reference cost and a noise cost. From the step responses and the estimated costs, it is clear that the bias was reduced with the second controller, showing that in this case the data-driven controller $C_2(z, \hat{\rho}_N)$ outperforms the model-based controller $C_1(z, \hat{\rho}_N)$, the main reason being that it has significantly smaller bias error due to its greater flexibility; hence it is better able to approximate the optimal controller.

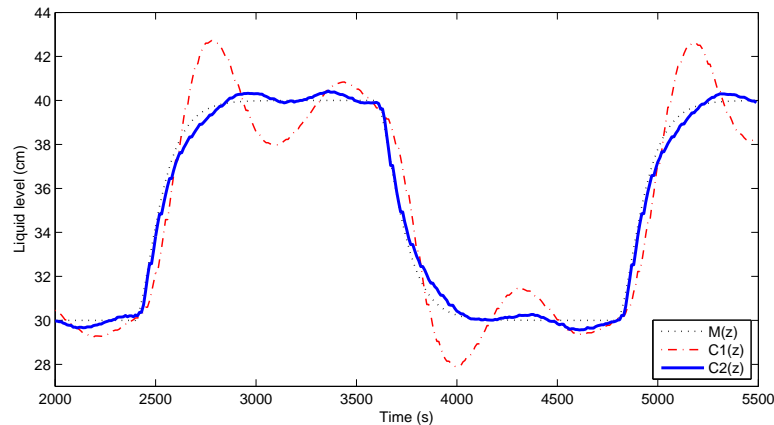

Fig. 10. Closed-loop responses with the identified controllers $C_1(z, \hat{\rho}_N)$ and $C_2(z, \hat{\rho}_N)$ compared with the desired reference model response.

6. Conclusions

A one-shot data-based method used to identify the ideal MR controller has been presented. The method consists in solving a PE identification problem, where the inverse of the ideal controller is identified from data collected on the system. More specifically, the controller structure is described with an identifiable part and a fixed part, and the choices for the fixed part allow us to consider different designs, from pure model-based to entirely data-driven controller design, both performed by the prediction error approach. Within this framework, it is possible to analyze and compare the statical properties of both approaches. We have shown that when the ideal controller belongs to the user-specified controller class, the controller variance is smaller when model-based control design is performed; however, the model reference cost is not significantly smaller with model-based design than with data-based design. On the other hand, in the more relevant case in which the ideal controller does not belong to the controller class, then DD design outperforms the indirect approach, both in controller variance and in achieved closed-loop model reference cost. The indirect approach in this case amounts to identification of a reduced order model of the plant. So, the bias distribution is made at the stage of identification of the model plant, whereas in the data-driven approach the bias distribution is made at the stage of controller estimation, taking account of the control objective. Practical results have confirmed this.

In doing so, we believe this paper has added useful insight into data-based MR design methods.

References

- [1] H. Hjalmarsson, S. Gunnarsson, M. Gevers, A convergent iterative restricted complexity control design scheme, in: Proc. 33rd IEEE Conf. on Decision and Control, Orlando, Florida, 1994, pp. 1735–1740.
- [2] H. Hjalmarsson, M. Gevers, S. Gunnarsson, O. Lequin, Iterative Feedback Tuning: theory and applications, IEEE Control Systems Magazine 18 (1998) 26–41.
- [3] M. Campi, A. Lecchini, S. Savaresi, Virtual Reference Feedback Tuning (VRFT): a direct method for the design of feedback controllers, Automatica 38 (2002) 1337–1346.

- [4] A. Karimi, L. Mišković, D. Bonvin, Iterative Correlation-Based Controller Tuning, *International Journal of Adaptive Control and Signal Processing* 18 (8) (2004) 645–664.
- [5] A. Karimi, K. van Heusden, D. Bonvin, Non-iterative data-driven controller tuning using the correlation approach, in: *Proc. European Control Conference, Kos, Greece, 2007*.
- [6] A. Bazanella, L. Campestrini, D. Eckhard, *Data-Driven Controller Design: The H2 Approach*, Springer, New York, USA, 2012.
- [7] L. Ljung, *System Identification: Theory for the User*, 2nd Edition, Prentice-Hall, Englewood Cliffs, NJ, 1999.
- [8] L. Campestrini, D. Eckhard, A. S. Bazanella, M. Gevers, Model reference control design by prediction error identification, in: *16th IFAC Symposium on System Identification, IFAC, Brussels, Belgium, 2012*, pp. 1478 – 1483.
- [9] G. R. Gonçalves da Silva, L. Campestrini, A. S. Bazanella, Automating the choice of the reference model for data-based control methods applied to PID controllers, in: *Proceedings of XX Congresso Brasileiro de Automática, SBA, Belo Horizonte, 2014*, pp. 1088–1095.
- [10] A. Bazanella, X. Bombois, M. Gevers, Necessary and sufficient conditions for uniqueness of the minimum in prediction error identification, *Automatica* (doi:10.1016/j.automatica.2012.06.018).
- [11] M. Campi, A. Lecchini, S. Savaresi, Virtual reference feedback tuning: a direct method for the design of feedback controllers, *Automatica* 38 (8) (2002) 1337 – 1346.
- [12] A. Karimi, K. van Heusden, D. Bonvin, Noniterative data-driven controller tuning using the correlation approach, in: *European Control Conference, IEEE, Kos Island, Greece, 2007*.
- [13] K. van Heusden, A. Karimi, T. Söderström, On identification methods for direct data-driven controller tuning, *International Journal of Adaptive Control and Signal Processing* 25 (5) (2011) 448–465.
- [14] L. Xie, L. Ljung, Asymptotic variance expressions for estimated frequency functions, *IEEE Transactions on Automatic Control* AC-46 (2001) 1887–1899.
- [15] B. Ninness, H. Hjalmarsson, Variance error quantifications that are exact for finite model order, *IEEE Transactions on Automatic Control* 49 (8) (2004) 1275–1291.
- [16] D. Eckhard, A. Bazanella, C. Rojas, H. Hjalmarsson, On the convergence of the prediction error method to its global minimum, in: *16th IFAC Symposium on System Identification, IFAC, Brussels, 2012*, pp. 698–703. doi:10.3182/20120711-3-BE-2027.00371.